

# Armoured WWII U.S. Jeep + SCR510 U.S. WWII radio set + workable leaf springs

for WWII U.S. 1/4 ton. truck

**GM35004** (VMT35008 + AVM35003 + VMD35000)

**UPDATED** level "a" 18-April-2011

for Tamiya kit, adaptable to Italeri and Revell kits

1/35 scale photoetched set for advanced modelers

**minor**  Made in Spain 2011  
[www.minor-web.com](http://www.minor-web.com)

**CAUTION** This product contain small pieces,  
not suitable for childrens under 10 years

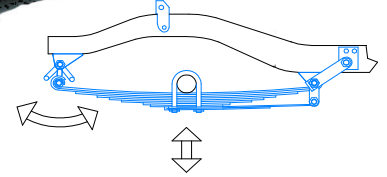
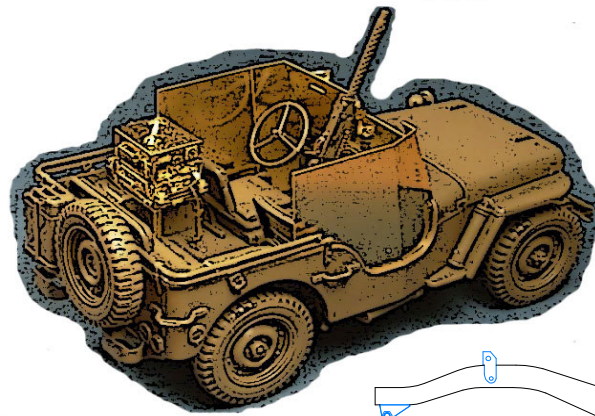

## Armoured WWII U.S. Jeep

 Bend  
 Symmetrically (Both sides)  
 **OP** Optional  
 Original parts  
 **minor** kit parts  
 Scratchbuilt or modified parts

## workable leaf springs

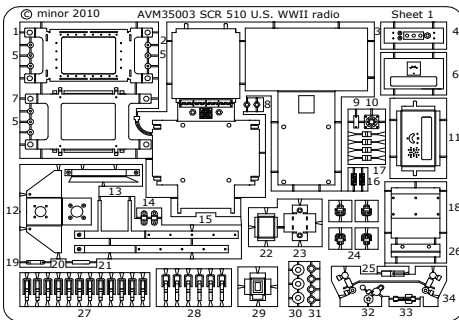
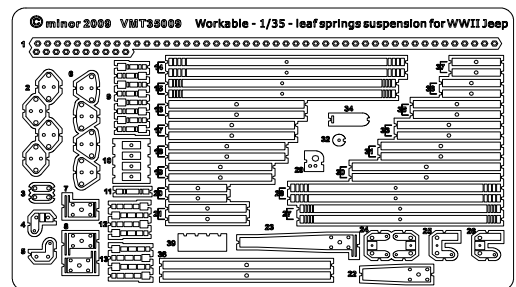
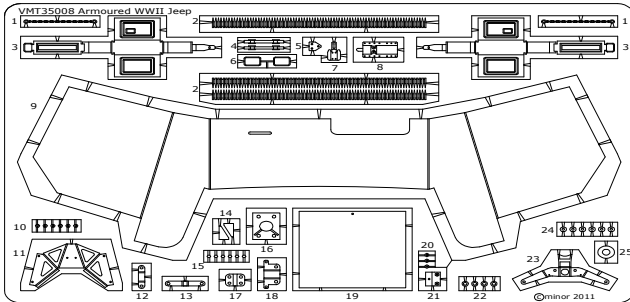

## SCR510 U.S. WWII radio set

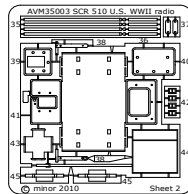

## Armoured WWII U.S. Jeep

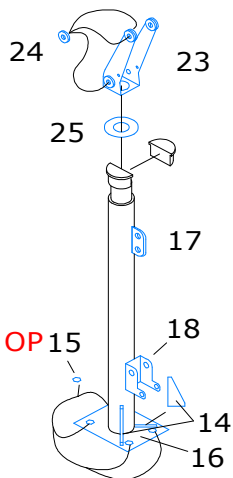
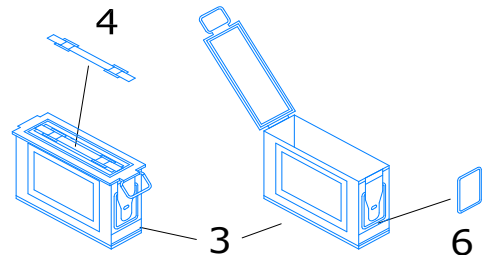

original kit parts

CUT the parts in red

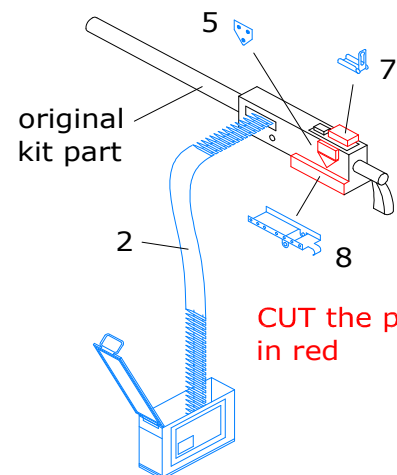
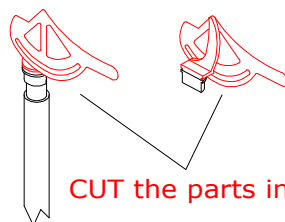

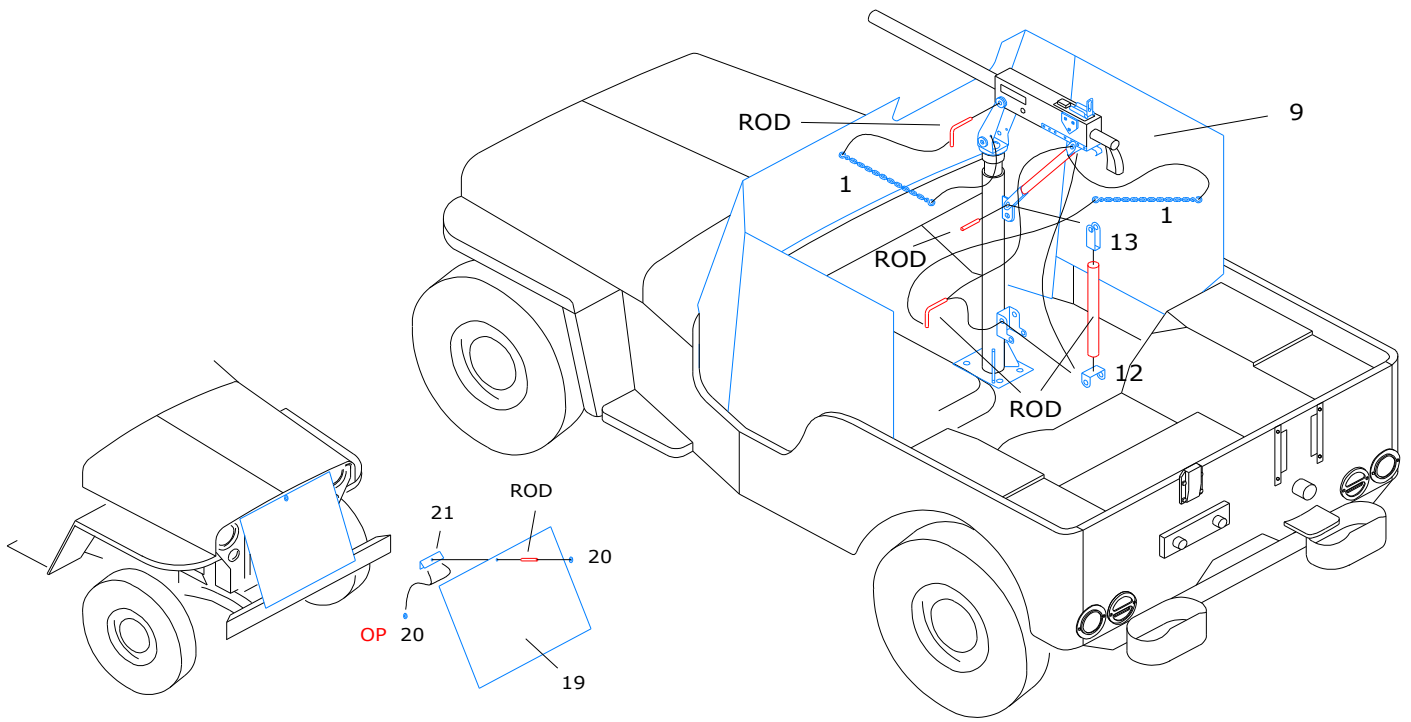

SCR510 U.S. WWII radio set

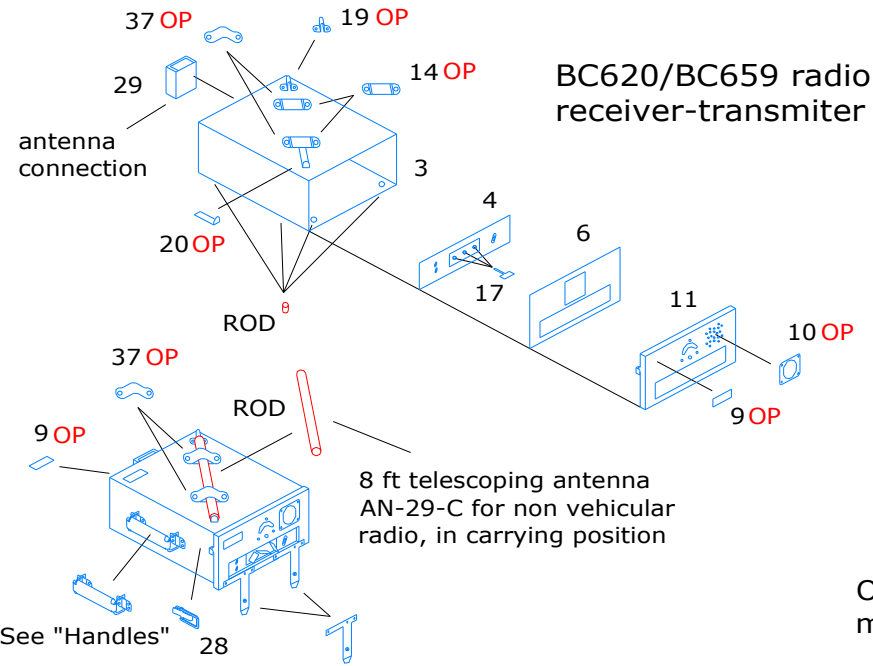

Book fasteners

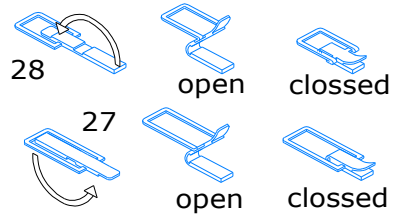

Handles

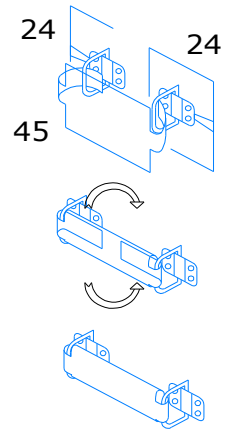

Opened for repair and maintenance

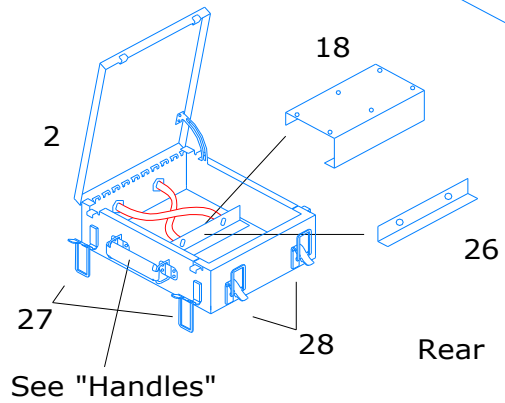

PE-120 power unit

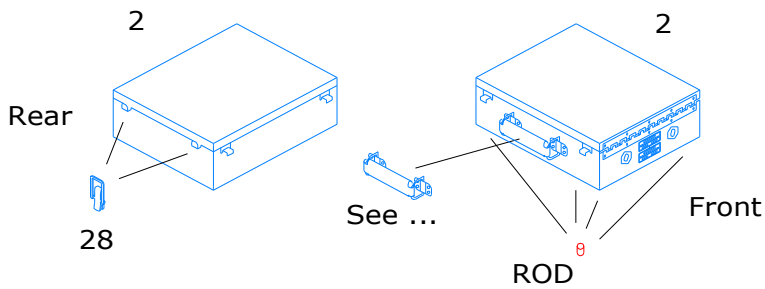

27 and 28 can be in open or closed position, see "Book fasteners"



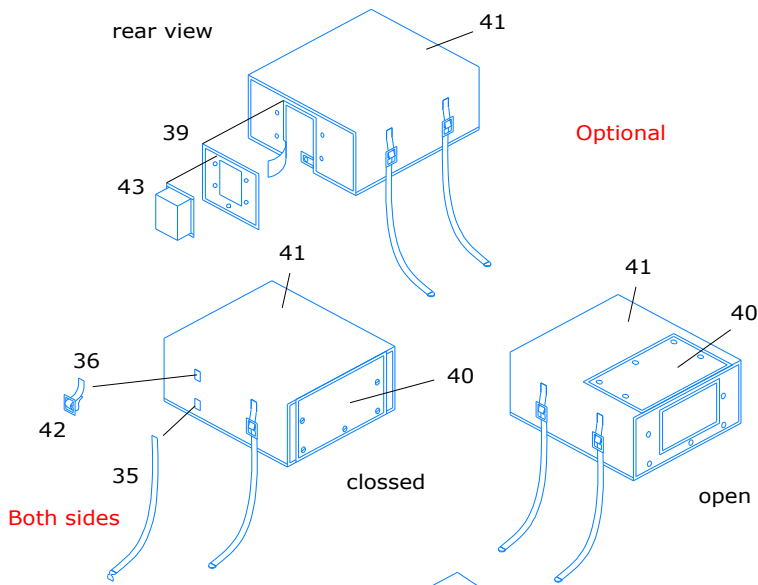

BG-77 cover, to protect the antenna base when masts are disassembled

fig.3

fig.2

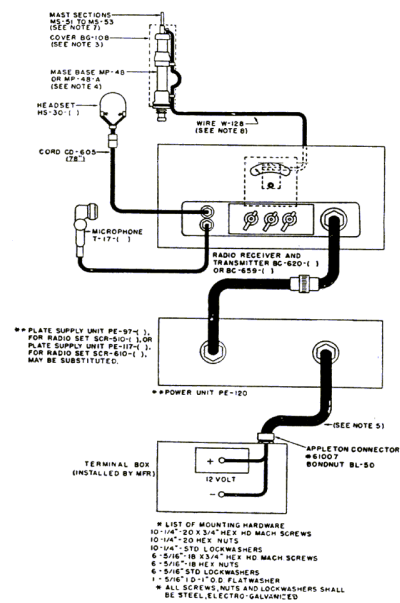

MP-48 mast base scratchbuilt

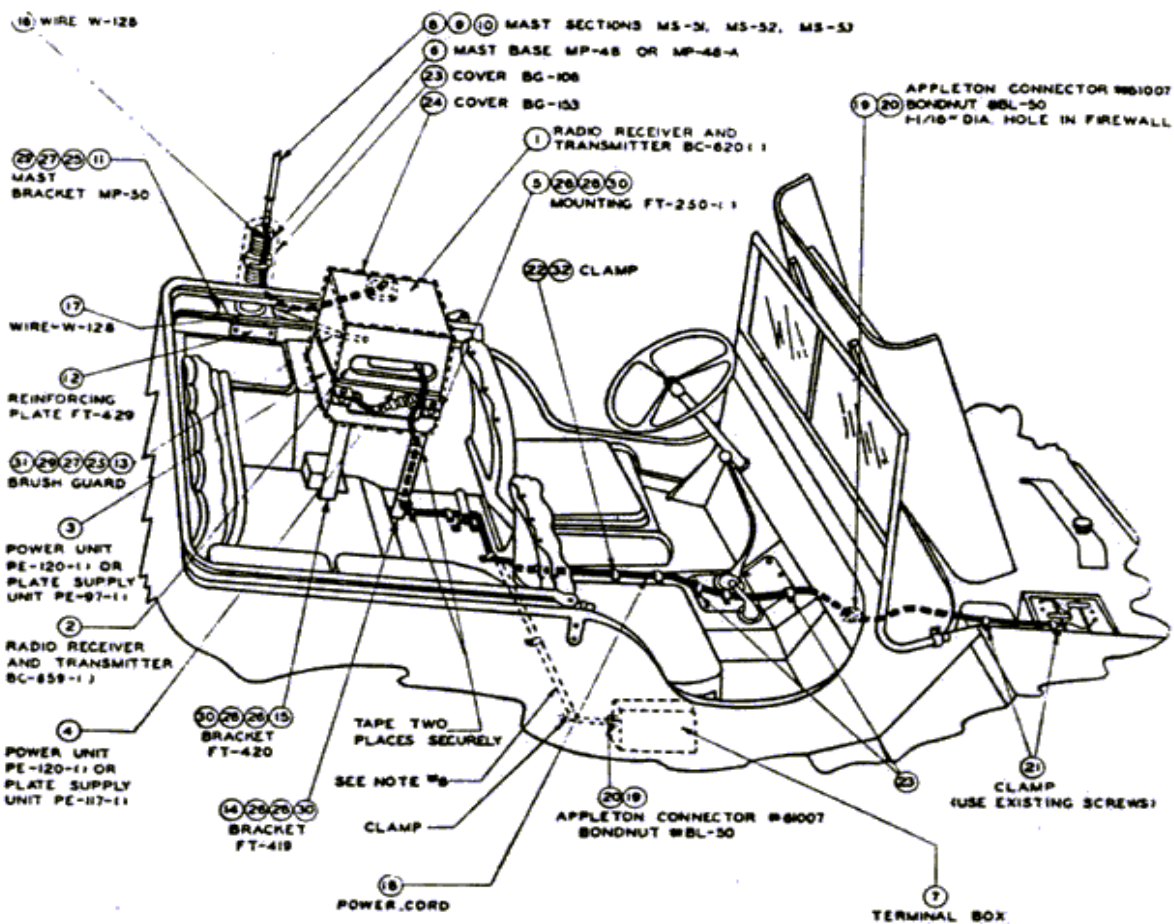
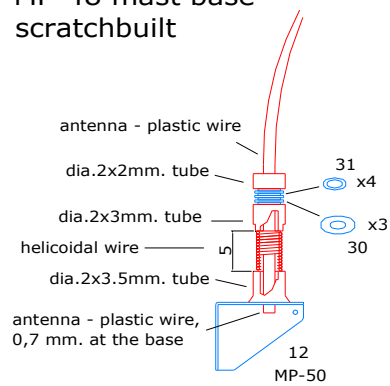

# workable leaf springs

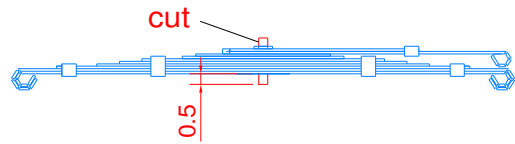
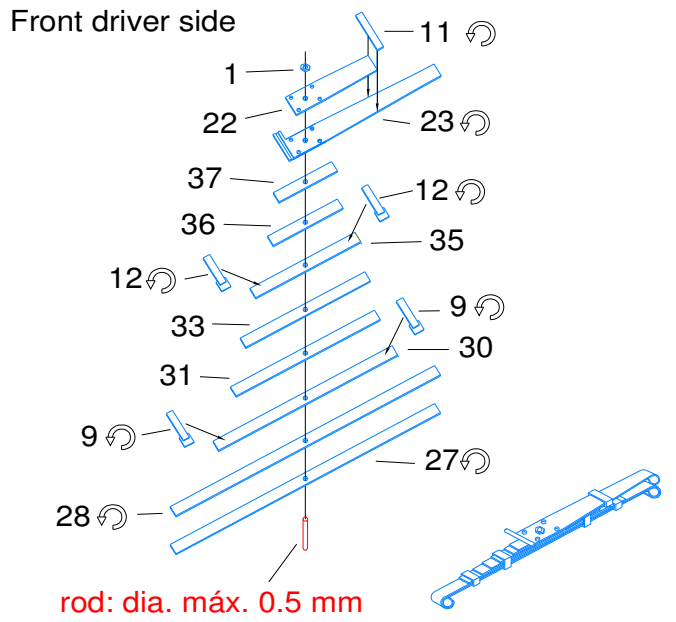
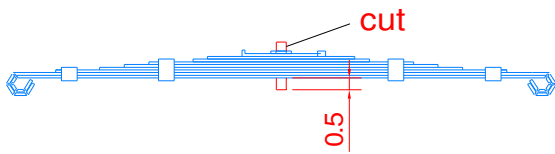
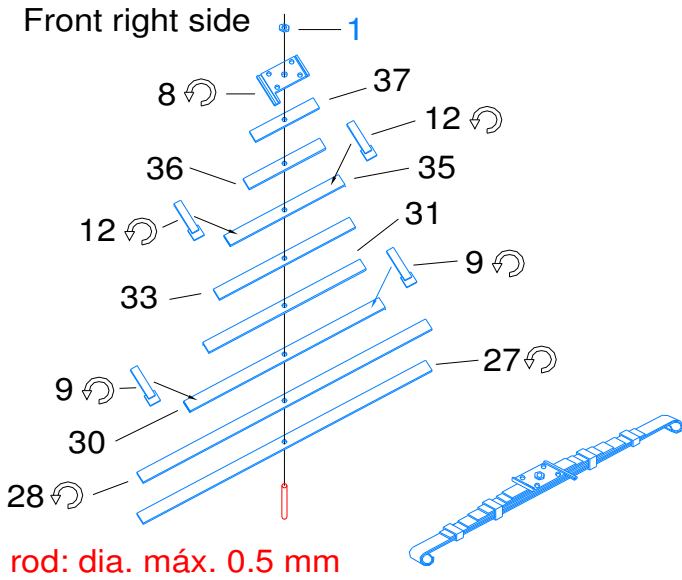

## Rear springs

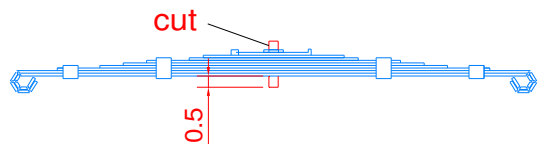
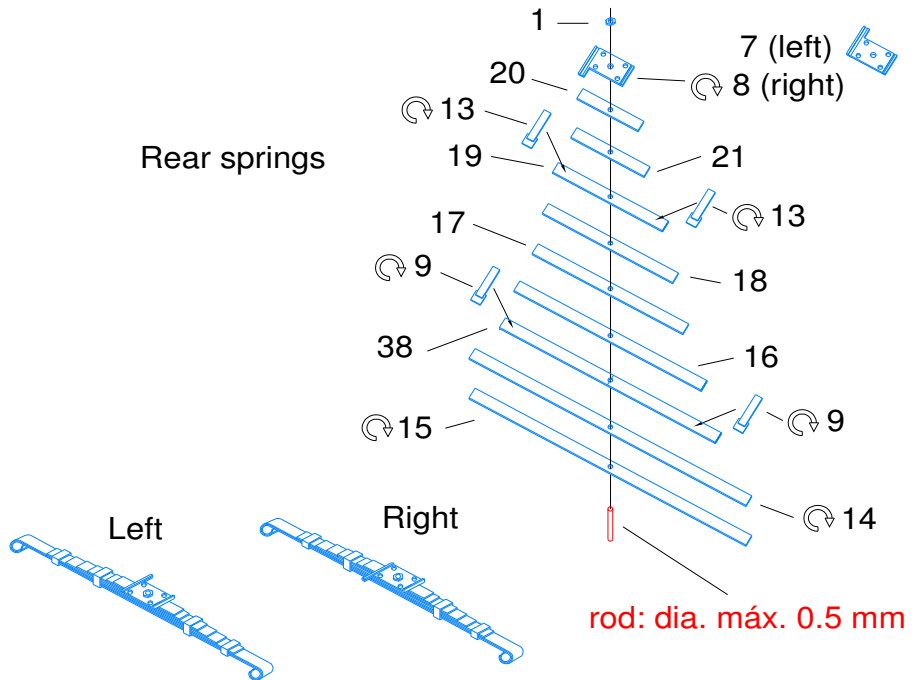

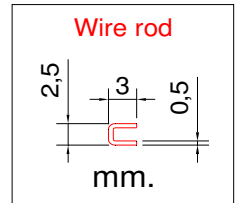
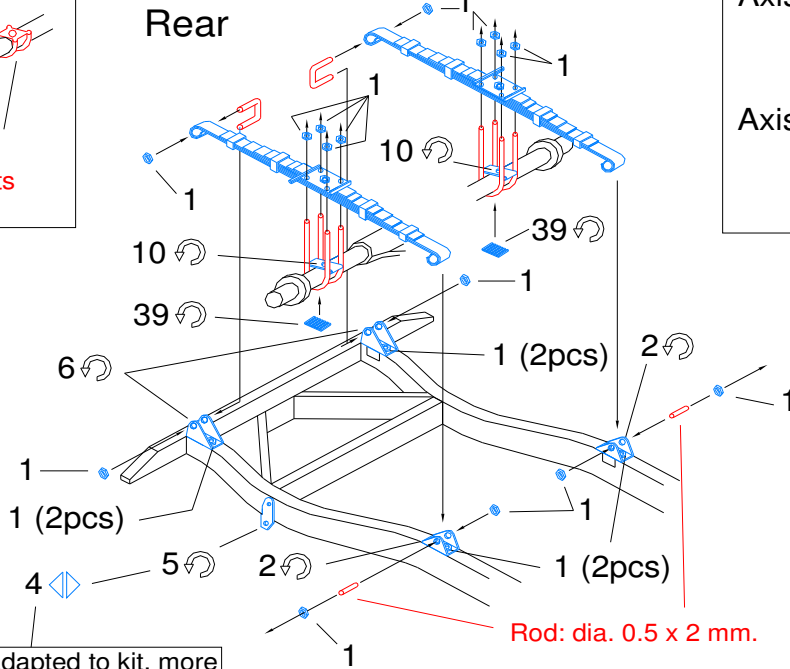
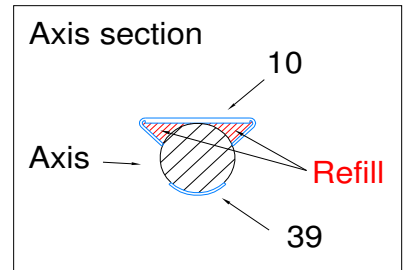
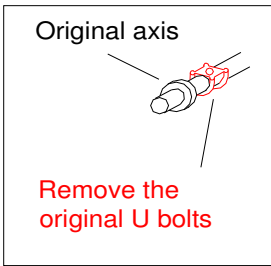

n° 4&5 are adapted to kit, more realistic pieces are n° 25&26.

Rod: dia. 0.5 x 2 mm.

Front

